



Technical Data Sheet

Product Name: PLCC6 5050 Extra Bright Red SMD LED

Part Number: RD5050-163URURURC-EB195

Customer: _____

Customer PN: _____

Version No.: A.4

Date: June 16th, 2015

| | | |
|----------------------------|--|--|
| <h2>Customer Approval</h2> | | |
| | | |

Instituted By: _____ **Checked By:** _____ **Approved By:** _____

Shenzhen RigDoo Optoelectronics Co., Ltd.

E-mail: info@rigdoo.com

Http://www.RigDoo.com



RigDoo Technical Data Sheet

Part No. : RD5050-163URURURC-EB195

Version

A.4

Issued date

June 16th, 2015

Page

1 of 11

1. Features

- Package (L/W/H) : 5.4 × 5.0 × 1.6 mm
- Color : Ultra Bright Red Full Color
- Lens: Water Clear Flat Mold
- EIA STD Package
- Meet ROHS, Green Product
- Compatible With SMT Automatic Equipment
- Compatible With Infrared Reflow Solder Process

2. Package Profile & Soldering PAD Suggested

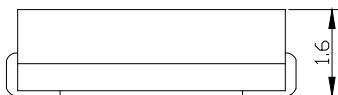
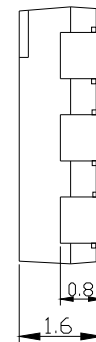
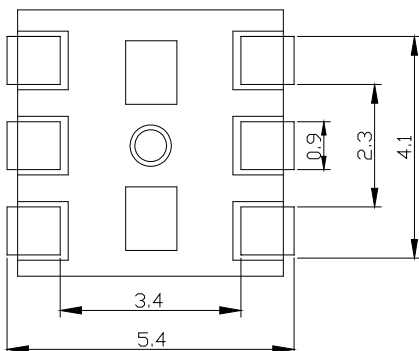
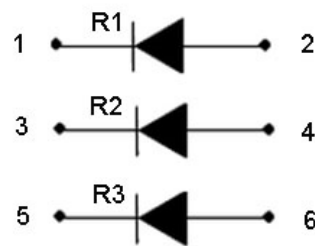
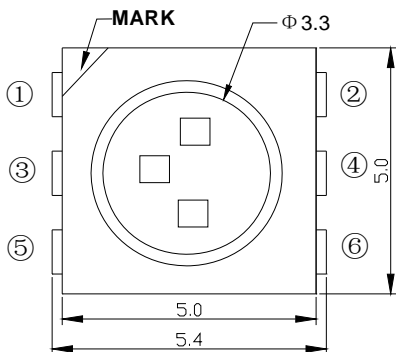

Notes: a. All dimensions are in millimeters ;
b. Tolerance is ± 0.10 mm unless otherwise noted.



RigDoo Technical Data Sheet

Part No. : RD5050-163URURURC-EB195

Version

A.4

Issued date

June 16th, 2015

Page

2 of 11

3. Soldering Profile Suggested

For Lead Solder

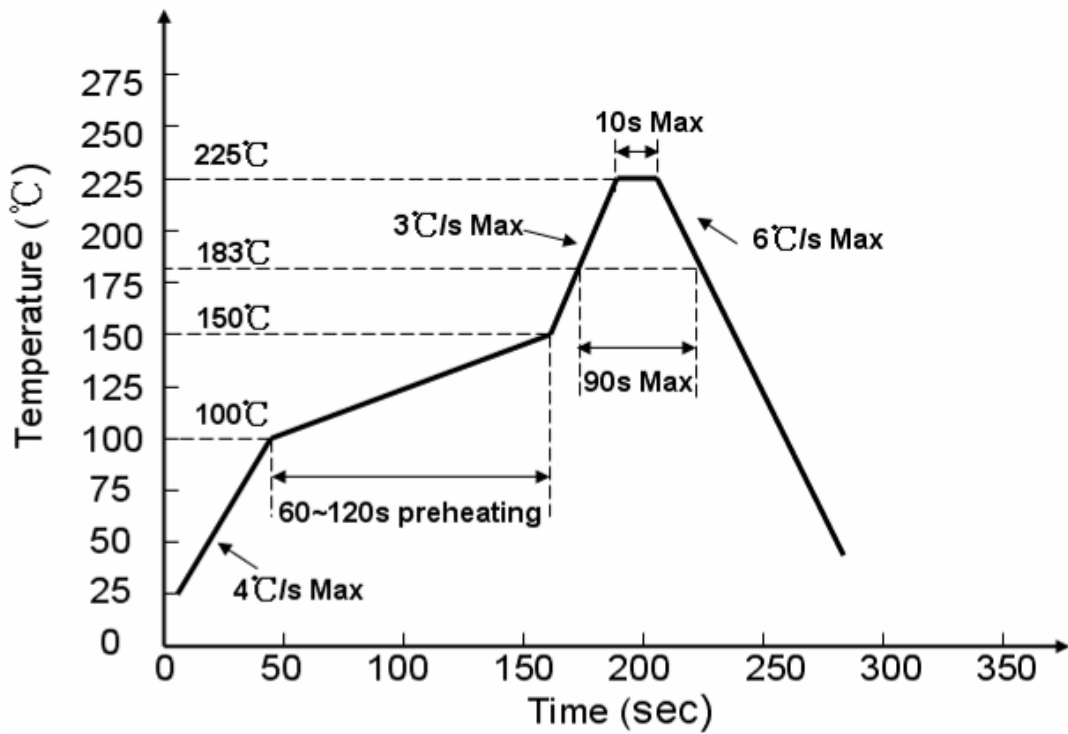

For Lead Free Solder

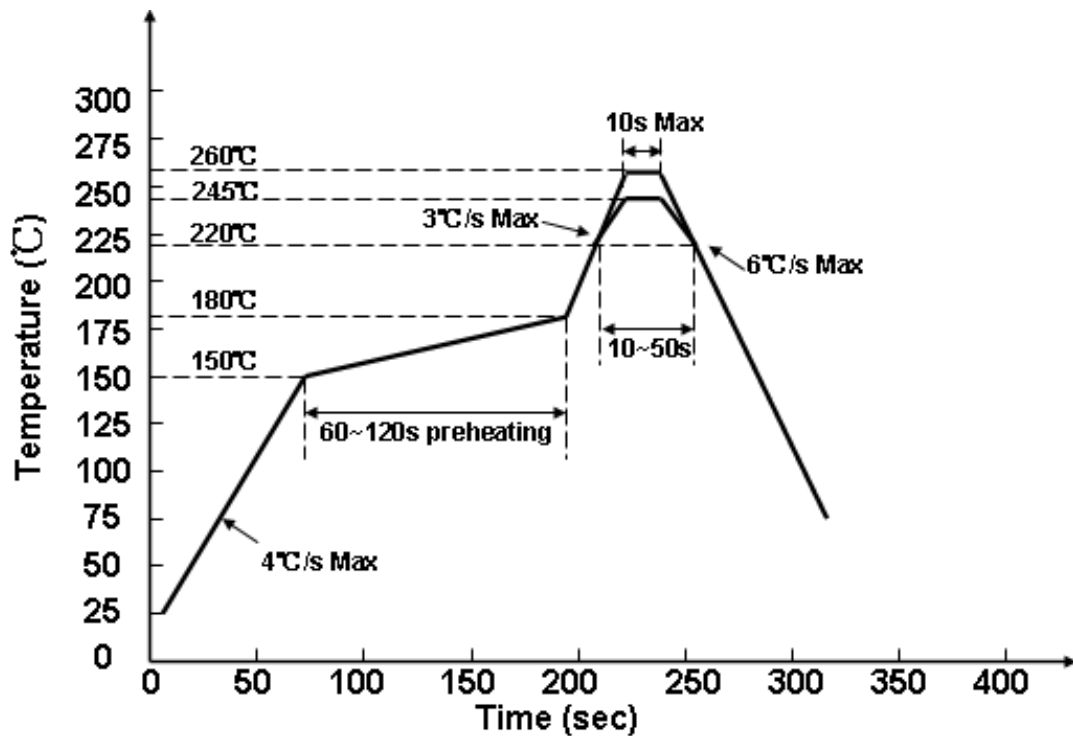

Notes:

We recommend the soldering temperature $245 \pm 5^\circ\text{C}$;

The maximum temperature should be limited to 260°C .



RigDoo Technical Data Sheet

Part No. : RD5050-163URURURC-EB195

Version

A.4

Issued date

June 16th, 2015

Page

3 of 11

4. Absolute Maximum Ratings At Ta=25°C

| Parameter | Symbol | Rating | | Unit |
|--|--------|---|-----|------|
| | | R1 | R2 | |
| Power Dissipation | Pd | R1 | 110 | mW |
| | | R2 | 110 | |
| | | R3 | 110 | |
| Peak Forward Current (1/10 Duty Cycle, 0.1ms Pulse Width) | IFP | R1 | 100 | mA |
| | | R2 | 100 | |
| | | R3 | 100 | |
| DC Forward Current | IF | R1 | 30 | mA |
| | | R2 | 30 | |
| | | R3 | 30 | |
| Reverse Voltage | VR | R1 | 5 | V |
| | | R2 | 5 | |
| | | R3 | 5 | |
| Operating Temperature Range | Topr | -30°C ~ + 85°C | | |
| Storage Temperature Range | Tstg | -40°C ~ + 90°C | | |
| Soldering Condition | Tsol | Reflow soldering : 260°C For 5 Seconds Hand soldering: 300°C For 3 Seconds | | |



RigDoo Technical Data Sheet

Part No. : RD5050-163URURURC-EB195

Version

A.4

Issued date

June 16th, 2015

Page

4 of 11

5. Electrical Optical Characteristics At Ta=25°C

| Parameter | Symbol | Color | Min. | Typ. | Max. | Unit | Test Condition |
|--------------------------|-----------------|-------|------|------|------|------|----------------|
| Luminous Intensity | IV | R1 | | 700 | | mcd | IF = 20mA |
| | | R2 | | 700 | | | |
| | | R3 | | 700 | | | |
| Dominant Wavelength | λ_d | R1 | 620 | 623 | 630 | nm | IF=20mA |
| | | R2 | 620 | 623 | 630 | | |
| | | R3 | 620 | 623 | 630 | | |
| Peak Wavelength | λ_p | R1 | --- | 624 | --- | nm | IF=20mA |
| | | R2 | --- | 624 | --- | | |
| | | R3 | --- | 624 | --- | | |
| Spectral Line Half-Width | $\Delta\lambda$ | R1 | -- | 30 | --- | nm | IF=20mA |
| | | R2 | --- | 30 | --- | | |
| | | R3 | --- | 30 | --- | | |
| Forward Voltage | VF | R1 | 1.8 | --- | 2.6 | V | IF=20mA |
| | | R2 | 1.8 | --- | 2.6 | | |
| | | R3 | 1.8 | --- | 2.6 | | |
| Reverse Current | IR | R1 | --- | --- | 5 | uA | VR=5V |
| | | R2 | --- | --- | 5 | | |
| | | R3 | --- | --- | 5 | | |
| Viewing Angle | 2 θ 1/2 | --- | --- | 120 | --- | deg | IF = 20mA |

- Notes:
1. Luminous intensity is measured with a light sensor and filter combination that approximates the CIE eye-response curve.
 2. θ 1/2 is the off-axis angle at which the luminous intensity is half the axial luminous intensity.
 3. The dominant wavelength, λ_d is derived from the CIE chromaticity diagram and represents the single wavelength which defines the color of the device.



RigDoo Technical Data Sheet

Part No. : RD5050-163URURURC-EB195

Version

A.4

Issued date

June 16th, 2015

Page

5 of 11

1) IV:

| Bin | Min | Max | Unit | Condition |
|-----|------|------|------|-----------|
| P2 | 1700 | 1900 | MCD | IF=60mA |
| Q1 | 1900 | 2100 | | |
| Q2 | 2100 | 2300 | | |
| R1 | 2300 | 2500 | | |
| R2 | 2500 | 2700 | | |
| | | | | |

2) VF:

| Bin | Min | Max | Unit | Condition |
|-----|-----|-----|------|-----------|
| 6 | 1.8 | 2.0 | V | IF=60mA |
| 7 | 2.0 | 2.2 | | |
| 8 | 2.2 | 2.4 | | |
| 9 | 2.4 | 2.6 | | |

3) WLD:

| Bin | Min | Max | Unit | Condition |
|-----|-----|-----|------|-----------|
| B | 620 | 625 | nm | IF=60mA |
| C | 625 | 630 | | |
| D | | | | |



RigDoo Technical Data Sheet

Part No. : RD5050-163URURURC-EB195

Version

A.4

Issued date

June 16th, 2015

Page

6 of 11

6. Typical Electrical-Optical Characteristics Curves

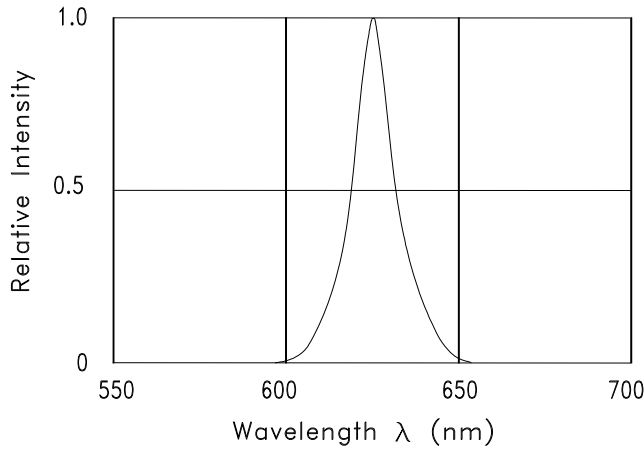

Fig.1 RELATIVE INTENSITY VS. WAVELENGTH

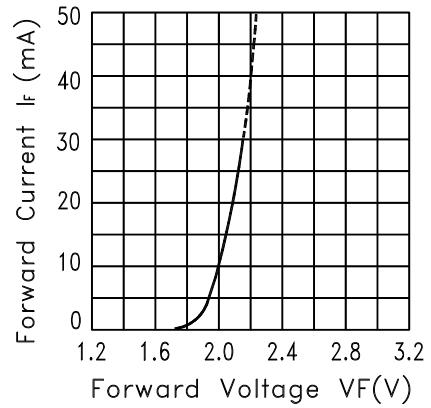

Fig.2 FORWARD CURRENT VS. FORWARD VOLTAGE

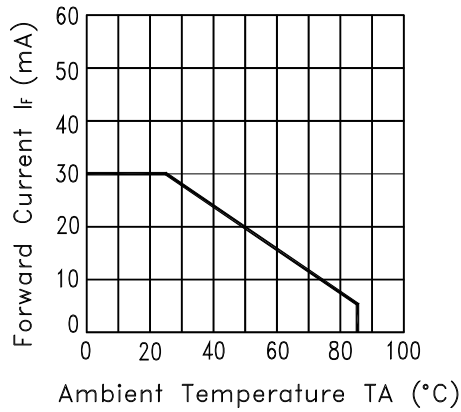

Fig.3 FORWARD CURRENT DERATING CURVE

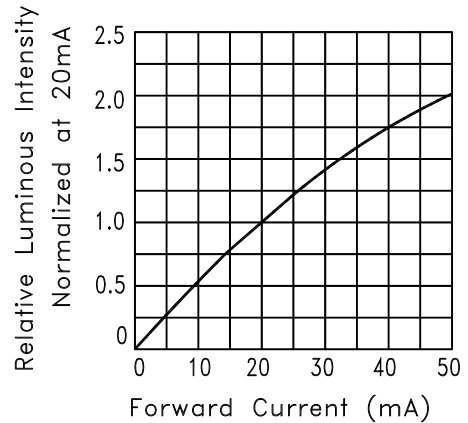

Fig.4 RELATIVE LUMINOUS INTENSITY VS. FORWARD CURRENT

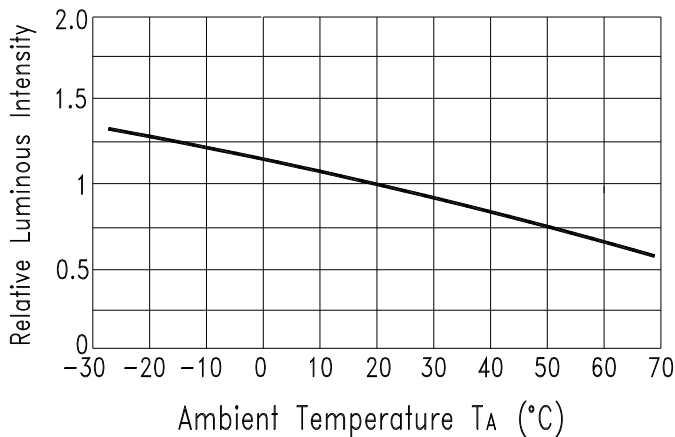

Fig.5 Luminous Intensity vs. Ambient Temperature

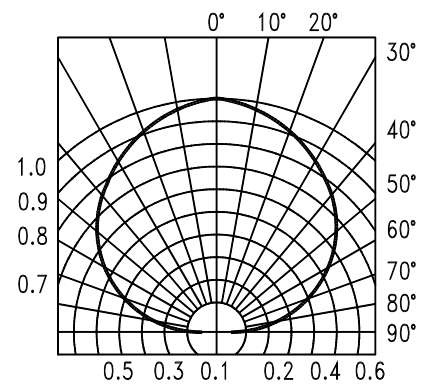

Fig.6 SPATIAL DISTRIBUTION



RigDoo Technical Data Sheet

Part No. : RD5050-163URURURC-EB195

Version

A.4

Issued date

June 16th, 2015

Page

7 of 11

7. Label explanation

CAT: Luminous Intensity Rank (unit : mcd)
HUE: Dominant Wavelength Rank (unit : nm)
REF: Forward Voltage Rank (unit : V)

Rank Tolerance:

- a. Luminous Intensity: $\pm 11\%$
- b. HUE: $\pm 1\text{nm}$
- c. Forward Voltage: $\pm 0.02\text{V}$



8. Moisture Resistant Packaging:

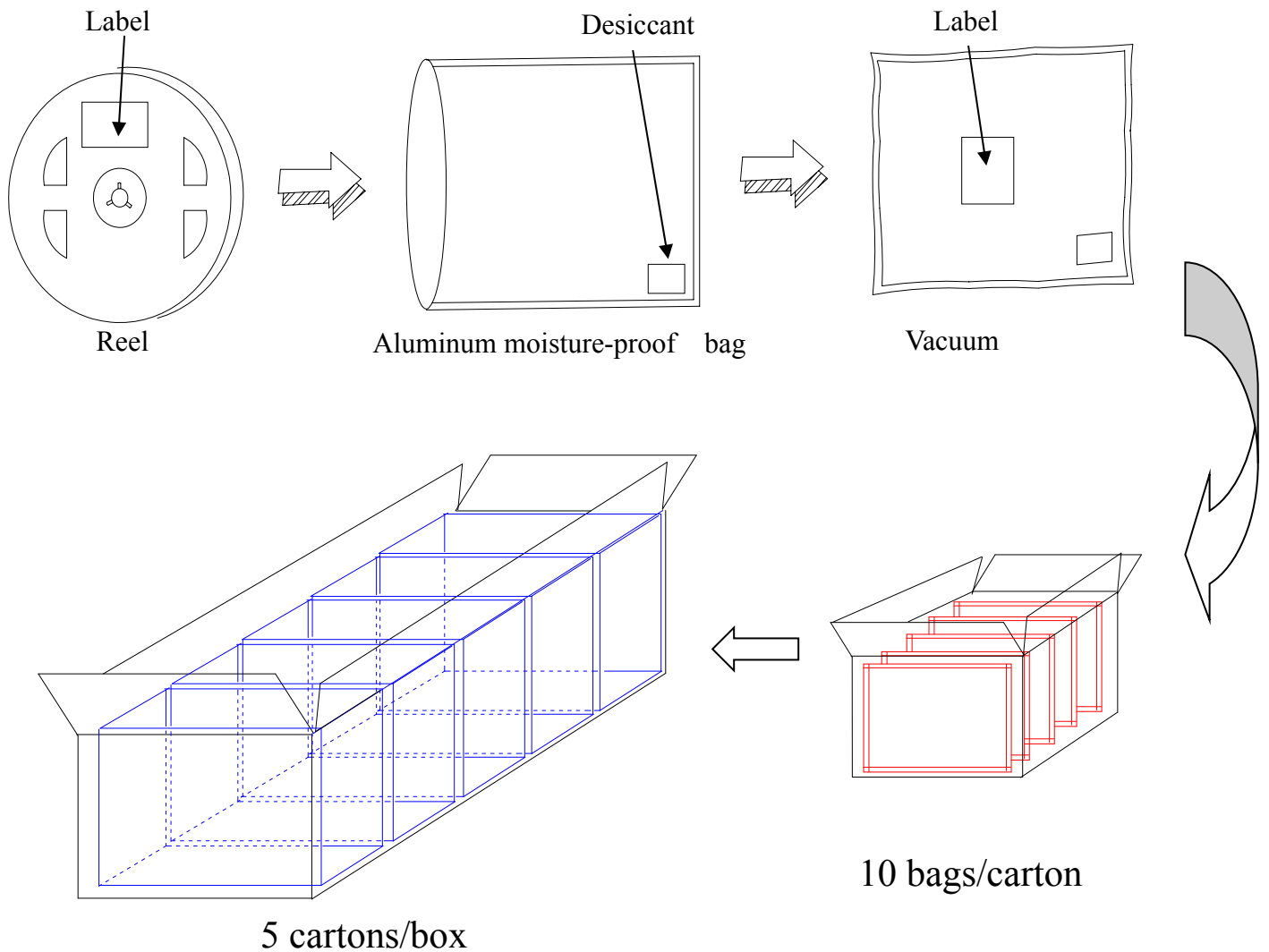



RigDoo Technical Data Sheet

Part No. : RD5050-163URURURC-EB195

Version

A.4

Issued date

June 16th, 2015

Page

8 of 11

9. Reliability Test

| Classification | Test Item | Test Condition | Reference Standard | Reference Standard |
|--------------------|---|--|----------------------------------|---|
| Endurance Test | Operation Life | Ta= Under Room Temperature As Per Data Sheet Maximum Rating | 1000HRS (-24HRS,+72HRS)*@20mA | MIL-STD-750D:1026 MIL-STD-883D:1005 JIS C 7021:B-1 |
| | High Temperature, High Humidity Storage | IR-Reflow In-Board, 2 Times Ta= 85±5°C,RH= 85% | 1000HRS±2HRS | JESD22-A101 |
| | High Temperature Storage | Ta= 105±5°C | 1000HRS (-24HRS,+72HRS) | MIL-STD-883D:1008 JIS C 7021:B-10 |
| | Low Temperature Storage | Ta= -55±5°C | 1000HRS (-24HRS,+72HRS) | JIS C 7021:B-12 |
| Environmental Test | Temperature Cycling | 105°C ~ 25°C ~ -55°C ~ 25°C 30mins 5mins 30mins 5mins | 10 Cycles | MIL-STD-202F:107D MIL-STD-750D:1051 MIL-STD-883D:1010 JIS C 7021:A-4 |
| | Thermal Shock | IR-Reflow In-Board, 2 Times 85 ± 5°C ~ -40°C ± 5°C 10mins 10mins | 10 Cycles | MIL-STD-202F:107D MIL-STD-750D:1051 MIL-STD-883D:1011 |
| | Solder Resistance | T.sol= 260 ± 5°C | 10 ± 1secs | MIL-STD-202F:210A MIL-STD-750D:2031 JIS C 7021:A-1 |
| | IR-Reflow Normal Process | Ramp-up rate(183°C to Peak) +3°C/ second max Temp. maintain at 125(±25)°C 120 seconds max Temp. maintain above 183°C 60-150 seconds Peak temperature range 235°C+5/-0°C Time within 5°C of actual Peak Temperature (tp) 10-30 seconds Ramp-down rate +6°C/second max | ----- | MIL-STD-750D:2031.2 J-STD-020C |
| | IR-Reflow Pb Free Process | Ramp-up rate(217°C to Peak) +3°C/ second max Temp. maintain at 175(±25)°C 180 seconds max Temp. maintain above 217°C 60-150 seconds Peak temperature range 260°C+0/-5°C Time within 5°C of actual Peak Temperature (tp) 20-40 seconds Ramp-down rate +6°C/second max | ----- | MIL-STD-750D:2031.2 J-STD-020C |
| | Solderability | T.sol= 235 ± 5°C Immersion rate 25±2.5 mm/sec Coverage ≧ 95% of the dipped surface | Immersion time 2±0.5 sec | MIL-STD-202F:208D MIL-STD-750D:2026 MIL-STD-883D:2003 IEC 68 Part 2-20 JIS C 7021:A-2 |

10. Cautions

Application

1. A LED is a current-operated device. The slight shift of voltage will cause big change of current, which will damage LEDs. Customer should use resistors in series for the Over-Current-Proof.
2. In order to ensure intensity uniformity on multiple LEDs connected in parallel in an application, it is recommended to use individual resistor separately, as shown in Circuit A below. The brightness of each LED shown in Circuit B might appear difference due to the differences in the I-V characteristics of those LEDs.

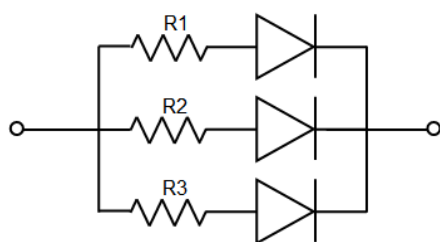

Circuit model A

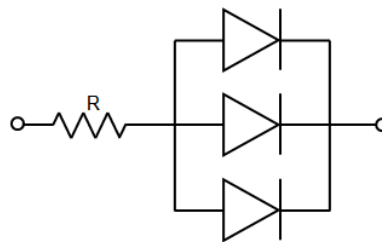

Circuit model B

3. High temperature may reduce LEDs' intensity and other performances, so keeping it away from heat source to get good performance is necessary.

Storage

1. Before opening original package, it is recommended to store them in the following environment:
Temperature: 5°C~30°C, Humidity: 85%RH max. When the inventory over 2 months, Should be done before treatment using dehumidification, Temperature: 60°C/8 hours.
2. After opening original package, the storage ambient for the LEDs should be in 5~30°C temperature and 60% or less relative humidity.
3. In order to avoid moisture absorption, it is recommended that the LEDs that out of the original package should be stored in a sealed container with appropriate desiccant, or in desiccators with nitrogen ambient.
4. The LEDs should be used within 48hrs (2 days) after opening the package. Once been mounted, soldering should be quick.
5. If the moisture absorbent material (silica gel) has faded away or the LEDs stored out of original package for more than 48hrs (2 days), baking treatment should be performed using the conditions: 60°C at least 24 hours.

ESD (Electrostatic Discharge)-Protection

A LED (especially the Blue、 White and Green product) is an ESD sensitive component, and static electricity or power surge will damage the LED. ESD-damaged LEDs will exhibit abnormal characteristics such as high reverse leakage current, low forward voltage, or “no light-up” at low currents, etc.

Some advice as below should be noticed:

1. A conductive wrist strap or anti-electrostatic glove should be worn when handling these LEDs.
2. All devices, equipment, machinery, work tables and storage racks, etc. must be properly grounded



RigDoo Technical Data Sheet

Part No. : RD5050-163URURURC-EB195

Version

A.4

Issued date

June 16th, 2015

Page

10 of 11

(Grounding impedance value within 10Ω) .

3. Use anti-static package or boxes to carry and storage LEDs. And ordinary plastic package or boxes is forbidden to use.
4. Use ionizer to neutralize the static charge during handling or operating.
5. All surfaces and objects within 1 ft close to LEDs measure less than 100V.

Cleaning

Use alcohol-based cleaning solvents such as IPA (isopropyl alcohol) to clean LEDs if necessary.

Soldering

1. Soldering condition refer to the draft “Soldering Profile Suggested” on page 1.
2. Reflow soldering should not be done more than 2 times.
3. Manual soldering is only suggested on repair and rework. The maximum soldering temperature should not exceed 300°C within 3 sec. And the maximum capacity of soldering iron is 30W in power.
4. During the soldering process, do not touch the lens at high temperature.
5. After soldering, any mechanical force on the lens or any excessive vibration shall not be accepted to apply, also the circuit board shall not be bent as well.

Others

1. The LEDs described here are intended to be used for ordinary electronic equipment (such as office equipment, communication equipment and household applications). Consult RigDoo’s Sales in advance for the applications in which exceptional reliability is required, particularly when the failure or malfunction of the LEDs may directly jeopardize life or health. (such as in aviation, transportation, traffic control equipment, medical and life support systems and safety devices).
2. The light output from the high luminous intensity LEDs may cause injury to human eyes when viewed directly.
3. The appearance and specifications of the product may be modified for improvement without prior notice.
4. LED operating environment and sulfur element composition cannot be over 100PPM in the LED mating.