



Technical Data Sheet

Product Name: PLCC4 2835 White / Warm White Bi-Color LED

Part Number: RD2835-72WAWD05W

Customer: _____

Customer PN: _____

Version: A.4

Date: Aug. 21st, 2015

<h2>Customer Approval</h2>		

Instituted By: _____ **Checked By:** _____ **Approved By:** _____

Shenzhen RigDoo Optoelectronics Co., Ltd.

E-mail: info@rigdoo.com

Http://www.RigDoo.com



RigDoo Technical Data Sheet

Part No. : RD2835-72WAWD05W

Version

A.4

Issued date

Aug. 21st, 2015

Page

1 of 11

1. Features

- Package (L/W/H) : 2.8×3.75×0.65 mm
- Color : Ultra High Bright White / Warm White Bi-Color
- Lens: Yellow Diffuse Flat Mold
- EIA STD Package
- Meet ROHS, Green Product
- Compatible With SMT Automatic Equipment
- Compatible With Infrared Reflow Solder Process

2. Package Profile & Soldering PAD Suggested

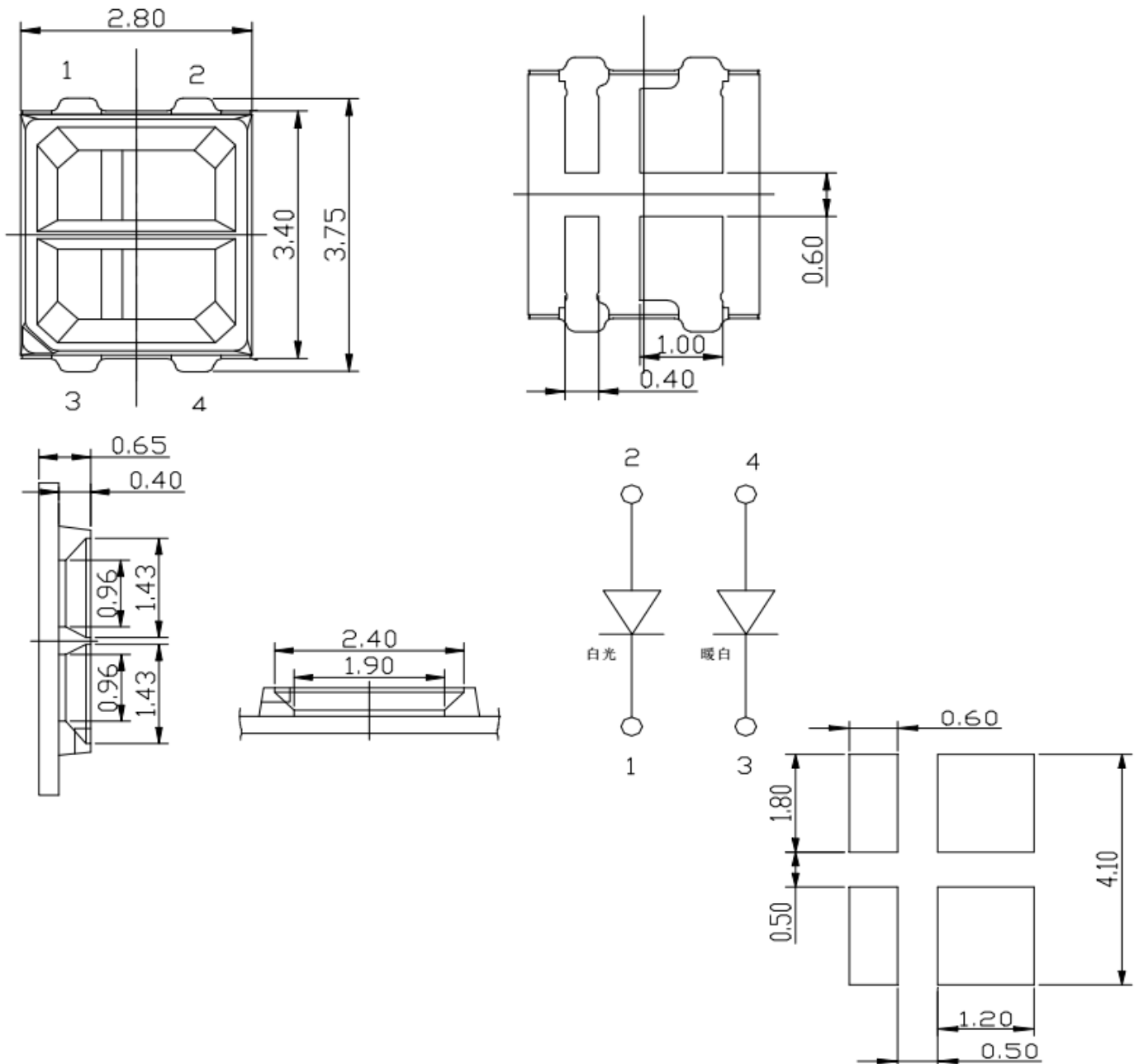



RigDoo Technical Data Sheet

Part No. : RD2835-72WAWD05W

Version

A.4

Issued date

Aug. 21st, 2015

Page

2 of 11

3. Soldering Profile Suggested

For Lead Solder

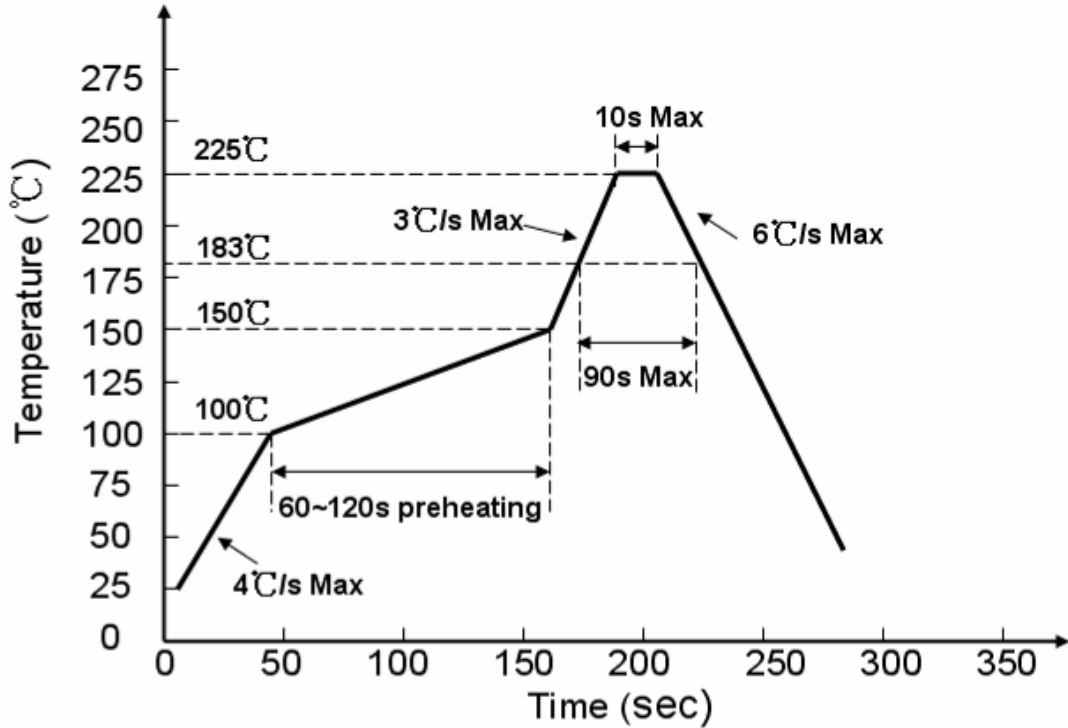

For Lead Free Solder

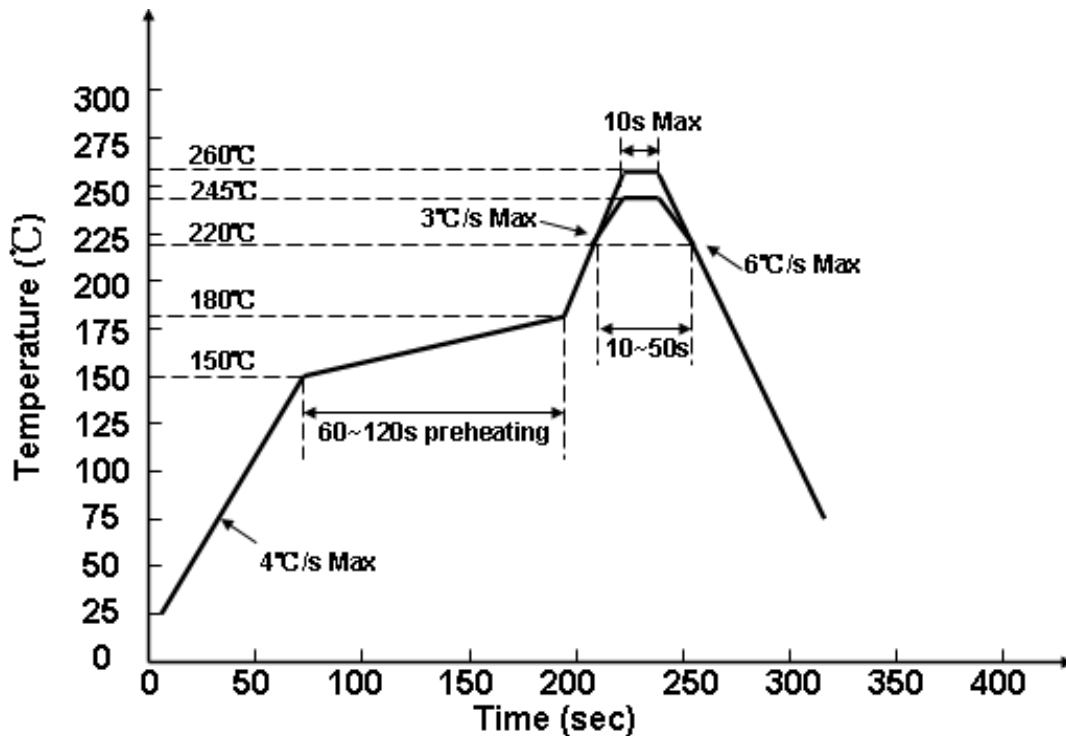

Notes:

We recommend the soldering temperature $245 \pm 5^\circ\text{C}$;

The maximum temperature should be limited to 260°C .



RigDoo Technical Data Sheet

Part No. : RD2835-72WAWD05W

Version

A.4

Issued date

Aug. 21st, 2015

Page

3 of 11

4. Absolute Maximum Ratings At Ta=25°C

Parameter	Symbol	Rating	Unit
Power Dissipation	Pd	500x2	mW
Peak Forward Current (1/10 Duty Cycle, 0.1ms Pulse Width)	IFP	200x2	mA
DC Forward Current	IF	150x2	mA
Reverse Voltage	VR	5	V
Operating Temperature Range	Topr	-40C ~ +85°C	
Storage Temperature Range	Tstg	-40°C ~ +100°C	
Soldering Condition	Tsol	Reflow soldering : 260°C For 5 Seconds Hand soldering: 300°C For 3 Seconds	



RigDoo Technical Data Sheet

Part No. : RD2835-72WAWD05W

Version

A.4

Issued date

Aug. 21st, 2015

Page

4 of 11

5. Electrical Optical Characteristics At Ta=25°C

Parameter	Symbol	Color	Min.	Typ.	Max.	Unit	Test Condition
Lumen	Φ	W	55	---	60	lm	IF = 60mA
	Φ	AW	55	---	60	lm	IF = 60mA
Color Rendering Index	Ra	W AW	---	80	---		IF = 60mA
Viewing Angle	2 θ 1/2	W AW	---	120	---	deg	IF =60mA
Color Temperature	CCT	W	6000	---	6500	K	IF = 60mA
	CCT	AW	2700	---	3000	K	IF = 60mA
Forward Voltage	VF	W AW	2.8	---	3.6	V	IF = 60mA
Reverse Current	IR	W AW	---	---	5	uA	VR=5V

Notes: 1. Luminous intensity is measured with a light sensor and filter combination that approximates the CIE eye-response curve.

2. θ 1/2 is the off-axis angle at which the luminous intensity is half the axial luminous intensity.

3. The dominant wavelength, λ_d is derived from the CIE chromaticity diagram and represents the single wavelength which defines the color of the device.



RigDoo Technical Data Sheet

Part No. : RD2835-72WAWD05W

Version

A.4

Issued date

Aug. 21st, 2015

Page

5 of 11

6 .Typical Electrical-Optical Characteristics Curves

Forward Current VS.
Forward Voltage

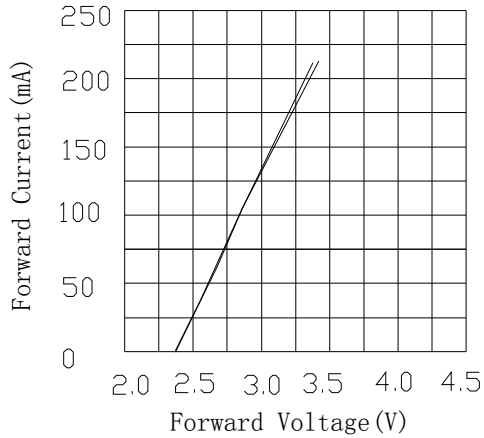

Forward Current VS.
Relative Intensity

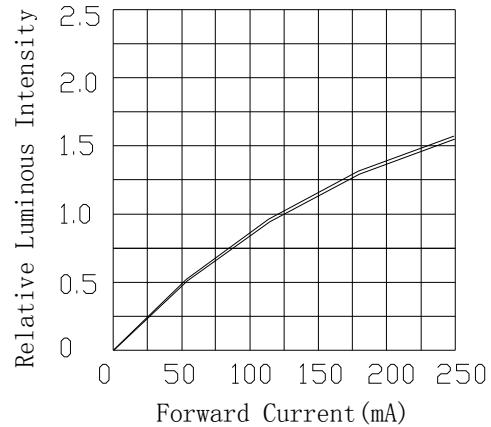

Ambient Temperature VS.
Forward Current

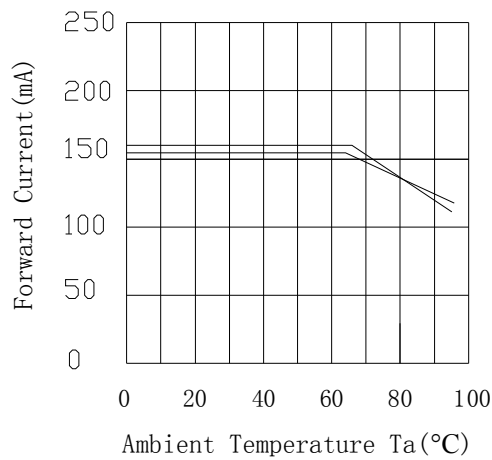

Ambient Temperature VS.
Relative Intensity

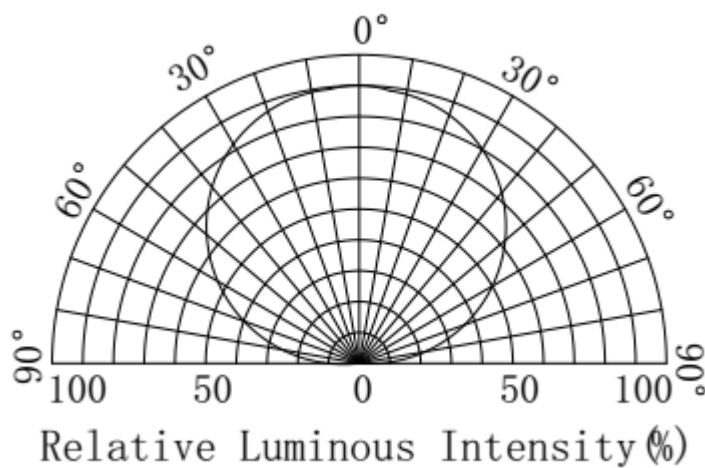
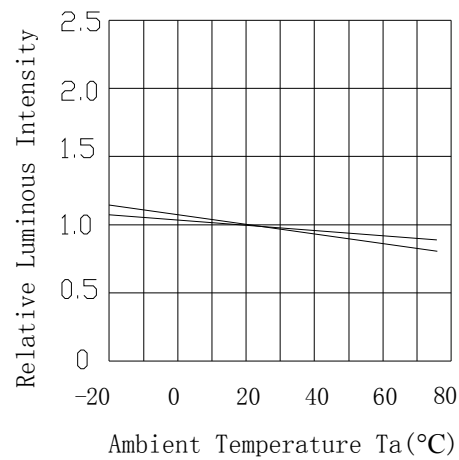



RigDoo Technical Data Sheet

Part No. : RD2835-72WAWD05W

Version

A.4

Issued date

Aug. 21st, 2015

Page

6 of 11

7 .Label Explanation

CAT: Luminous Intensity Rank (unit : mcd)

HUE: CIE 1931 Coordinate Rank

REF: Forward Voltage Rank (unit : V)

Rank Tolerance:

a. Luminous Intensity: $\pm 11\%$

b. HUE: ± 0.005

c. Forward Voltage: $\pm 0.02V$

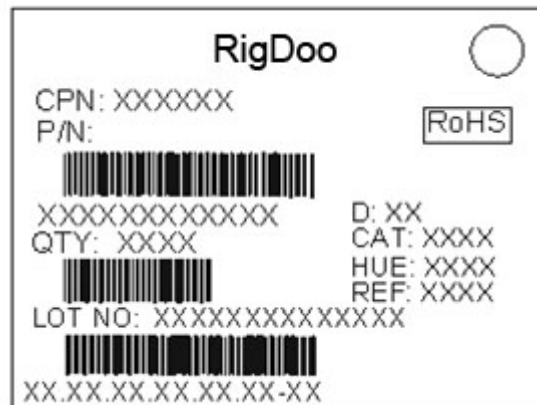



RigDoo Technical Data Sheet

Part No. : RD2835-72WAWD05W

Version

A.4

Issued date

Aug. 21st, 2015

Page

7 of 11

8. Tape Leader & Trailer Dimensions And Reel

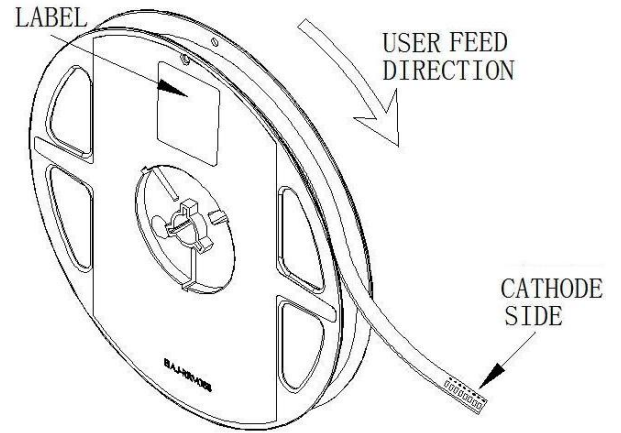
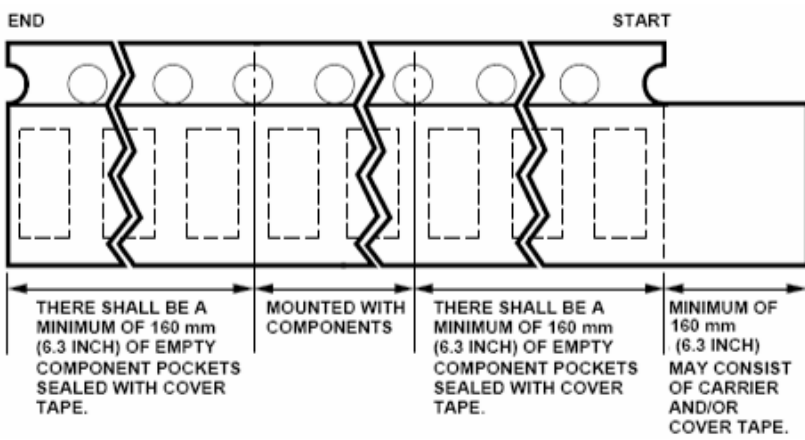

9. Packaging:

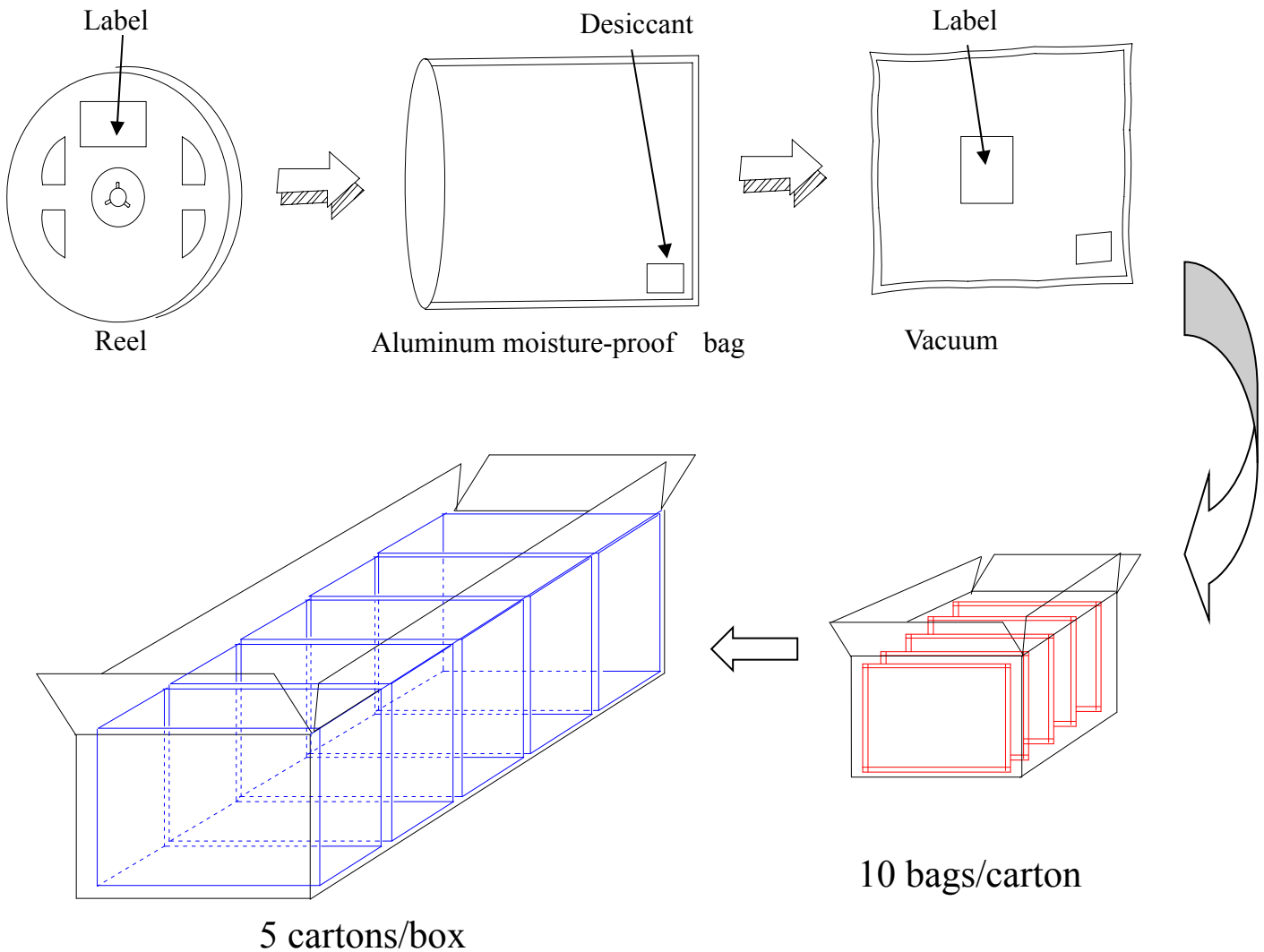



RigDoo Technical Data Sheet

Part No. : RD2835-72WAWD05W

Version

A.4

Issued date

Aug. 21st, 2015

Page

8 of 11

10. Reliability Test

Classification	Test Item	Test Condition	Reference Standard	Reference Standard
Endurance Test	Operation Life	Ta= Under Room Temperature As Per Data Sheet Maximum Rating	1000HRS (-24HRS,+72HRS)*@20mA	MIL-STD-750D:1026 MIL-STD-883D:1005 JIS C 7021:B-1
	High Temperature, High Humidity Storage	IR-Reflow In-Board, 2 Times Ta= 85±5°C,RH= 85%	1000HRS±2HRS	JESD22-A101
	High Temperature Storage	Ta= 105±5°C	1000HRS (-24HRS,+72HRS)	MIL-STD-883D:1008 JIS C 7021:B-10
	Low Temperature Storage	Ta= -55±5°C	1000HRS (-24HRS,+72HRS)	JIS C 7021:B-12
Environmental Test	Temperature Cycling	105°C ~ 25°C ~ -55°C ~ 25°C 30mins 5mins 30mins 5mins	10 Cycles	MIL-STD-202F:107D MIL-STD-750D:1051 MIL-STD-883D:1010 JIS C 7021:A-4
	Thermal Shock	IR-Reflow In-Board, 2 Times 85 ± 5°C ~ -40°C ± 5°C 10mins 10mins	10 Cycles	MIL-STD-202F:107D MIL-STD-750D:1051 MIL-STD-883D:1011
	Solder Resistance	T.sol= 260 ± 5°C	10 ± 1secs	MIL-STD-202F:210A MIL-STD-750D:2031 JIS C 7021:A-1
	IR-Reflow Normal Process	Ramp-up rate(183°C to Peak) +3°C/ second max Temp. maintain at 125(±25)°C 120 seconds max Temp. maintain above 183°C 60-150 seconds Peak temperature range 235°C+5/-0°C Time within 5°C of actual Peak Temperature (tp) 10-30 seconds Ramp-down rate +6°C/second max	-----	MIL-STD-750D:2031.2 J-STD-020C
	IR-Reflow Pb Free Process	Ramp-up rate(217°C to Peak) +3°C/ second max Temp. maintain at 175(±25)°C 180 seconds max Temp. maintain above 217°C 60-150 seconds Peak temperature range 260°C+0/-5°C Time within 5°C of actual Peak Temperature (tp) 20-40 seconds Ramp-down rate +6°C/second max	-----	MIL-STD-750D:2031.2 J-STD-020C
	Solderability	T.sol= 235 ± 5°C Immersion rate 25±2.5 mm/sec Coverage ≧95% of the dipped surface	Immersion time 2±0.5 sec	MIL-STD-202F:208D MIL-STD-750D:2026 MIL-STD-883D:2003 IEC 68 Part 2-20 JIS C 7021:A-2



RigDoo Technical Data Sheet

Part No. : RD2835-72WAWD05W

Version

A.4

Issued date

Aug. 21st, 2015

Page

9 of 11

11. Cautions

Application

1. A LED is a current-operated device. The slight shift of voltage will cause big change of current, which will damage LEDs. Customer should use resistors in series for the Over-Current-Proof.
2. In order to ensure intensity uniformity on multiple LEDs connected in parallel in an application, it is recommended to use individual resistor separately, as shown in Circuit A below. The brightness of each LED shown in Circuit B might appear difference due to the differences in the I-V characteristics of those LEDs.

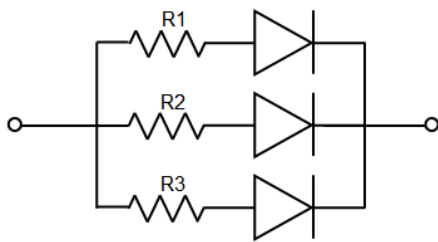

Circuit model A

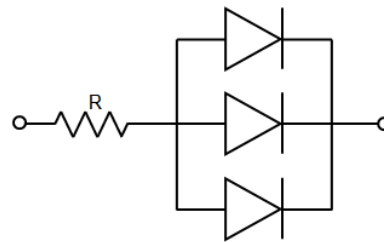

Circuit model B

3. High temperature may reduce LEDs' intensity and other performances, so keeping it away from heat source to get good performance is necessary.

Storage

1. Before opening original package, it is recommended to store them in the following environment:
Temperature: 5°C~30°C; Humidity: 85%RH max. When the inventory over 2 months, should be done before treatment using dehumidification, Temperature: 60°C/8 hours.
2. After opening original package, the storage ambient for the LEDs should be in 5~30°C temperature and 60% or less relative humidity.
3. In order to avoid moisture absorption, it is recommended that the LEDs that out of the original package should be stored in a sealed container with appropriate desiccant, or in desiccators with nitrogen ambient.
4. The LEDs should be used within 48hrs (2 days) after opening the package. Once been mounted, soldering should be quick.
5. If the moisture absorbent material (silica gel) has faded away or the LEDs stored out of original package for more than 48hrs (2 days), baking treatment should be performed using the conditions: 60°C at least 24 hours.

ESD (Electrostatic Discharge)-Protection

A LED (especially the Blue、 White and Green product) is an ESD sensitive component, and static electricity or power surge will damage the LED. ESD-damaged LEDs will exhibit abnormal characteristics such as high reverse leakage current, low forward voltage, or “no light-up” at low currents, etc.

Some advice as below should be noticed:



RigDoo Technical Data Sheet

Part No. : RD2835-72WAWD05W

Version

A.4

Issued date

Aug. 21st, 2015

Page

10 of 11

1. A conductive wrist strap or anti-electrostatic glove should be worn when handling these LEDs.
2. All devices, equipment, machinery, work tables and storage racks, etc. must be properly grounded.
(Grounding impedance value within 10Ω)
3. Use anti-static package or boxes to carry and storage LEDs. And ordinary plastic package or boxes is forbidden to use.
4. Use ionizer to neutralize the static charge during handling or operating.
5. All surfaces and objects within 1 ft close to LEDs measure less than 100V.

Cleaning

Use alcohol-based cleaning solvents such as IPA (isopropyl alcohol) to clean LEDs if necessary.

Soldering

1. Soldering condition refer to the draft "Soldering Profile Suggested" on page 1.
2. Reflow soldering should not be done more than 2 times.
3. Manual soldering is only suggested on repair and rework. The maximum soldering temperature should not exceed 300°C within 3 sec. And the maximum capacity of soldering iron is 30W in power.
4. During the soldering process, do not touch the lens at high temperature.
5. After soldering, any mechanical force on the lens or any excessive vibration shall not be accepted to apply, also the circuit board shall not be bent as well.

Others

1. The LEDs described here are intended to be used for ordinary electronic equipment (such as office equipment, communication equipment and household applications). Consult RigDoo's Sales in advance for the applications in which exceptional reliability is required, particularly when the failure or malfunction of the LEDs may directly jeopardize life or health. (such as in aviation, transportation, traffic control equipment, medical and life support systems and safety devices).
2. The light output from the high luminous intensity LEDs may cause injury to human eyes when viewed directly.
3. The appearance and specifications of the product may be modified for improvement without prior notice.
4. LED operating environment and sulfur element composition cannot be over 100PPM in the LED mating